

## CAMDEN MOUNTING BOXES

### FEATURES

- THE INDUSTRY'S LARGEST ASSORTMENT OF MOUNTING BOXES, ESCUTCHEONS, TRIM PLATES AND SLEEVES.
- SOLUTIONS FOR SURFACE AND FLUSH MOUNTING, INDOOR, OUTDOOR AND WATER TIGHT APPLICATIONS.
- FLAME AND IMPACT RESISTANT POLYMER (ABS) MODELS.
- HEAVY GAUGE STAINLESS AND ALUMINUM MODELS

### NARROW/JAMB MOUNTING BOXES

#### MODEL: CM-23

**Size:** Narrow/Jamb width  
**Type:** Surface mount box  
**Construction:** Flame and impact resistant black polymer (ABS)  
**Application:** Indoor/outdoor, wired  
**For Switch Series:** CM-25, CM-250, CM-310  
**Cover Plate:** CM-23CP

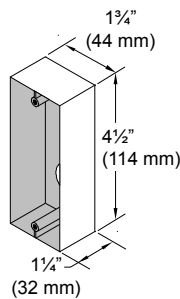

#### MODEL: CM-23D

**Size:** Narrow/Jamb width, extra depth  
**Type:** Surface mount box  
**Construction:** Flame and impact resistant black polymer (ABS)  
**Application:** Indoor/outdoor, wired. Required for wireless.  
**For Switch Series:** CM-25, CM-170, CM-250, CM-310, CM-325/N, CM-2200

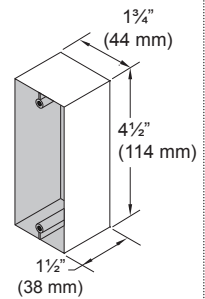

### SINGLE GANG MOUNTING BOXES

#### MODEL: CM-34BL

**Size:** Single gang, std. depth  
**Type:** Surface mount box  
**Construction:** Double wall, black (ABS)  
**Application:** Indoor, wired or wireless  
**For Switch Series:** CM-35, CM-180, CM-190/3/4, CM-280, CM-300, CM-325, CM-400, CM-700, CM-1200  
**Gasket:** CM-120G  
**Cover Plate:** CM-34CP

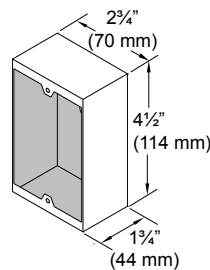

#### MODEL: CM-34AL

**Size:** Single gang, std. depth  
**Type:** Surface mount box, threaded conduit entry  
**Construction:** Heavy duty cast aluminum  
**Application:** Water tight, wired  
**For Switch Series:** CM-35, CM-180, CM-190/3/4, CM-280, CM-300, CM-325, CM-400, CM-4000, CM-5000, CM-700, CM-1100, CM-1200, supplied with CM-1000 Series  
**Gasket:** CM-120G

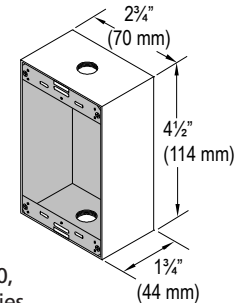

#### MODEL: CM-34D

**Size:** Single gang, extra depth  
**Type:** Surface mount box  
**Construction:** Heavy duty grey polymer  
**Application:** Indoor/outdoor, wired. Required for wireless  
**For Switch Series:** CM-30, CM-3000, CM-4085/5085/7085/8085  
**Gasket:** CM-120G

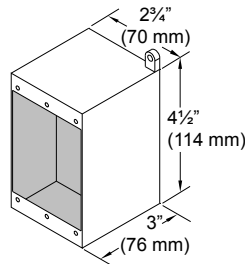

#### MODEL: CM-31

**Size:** Single gang  
**Type:** Sleeve for standard 2" x 4" surface electrical box  
**Construction:** Heavy gauge stainless steel  
**Application:** Adds brushed SS finish to standard electrical box  
**For Switch Series:** CM-35, CM-180, CM-190/3/4, CM-280, CM-300, CM-325, CM-1200

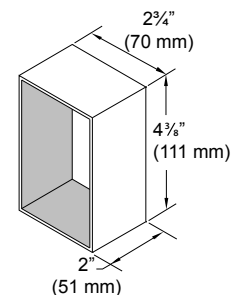

# CAMDEN MOUNTING BOXES

## MODEL: CM-66

**Size:** Single gang, std depth

**Type:** 7" x 7" dress plate and standard 2" x 4" flush electrical box

**Construction:** Heavy gauge stainless steel

**Application:** Extra wide trim plate c/w box to cover double gang sized openings

**For Switch Series:**

CM-35, CM-40, CM-41, CM-45, CM-60

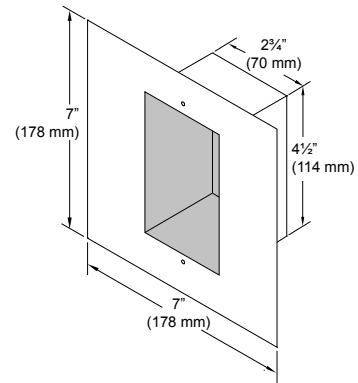

## DOUBLE GANG/SQUARE MOUNTING BOXES

### MODEL: CM-43CBL

**Size:** 5" Square, std. depth

**Type:** Surface mount box

**Construction:** Double wall, black (ABS)

**Application:** Indoor/outdoor, wired. Required for wireless.

**Cover Plate:** CM-43CP

**For Switch Series:**

CM-41, CM-45, CM-46

**CM-43CBLA:** Surface Box for CM-325W switches

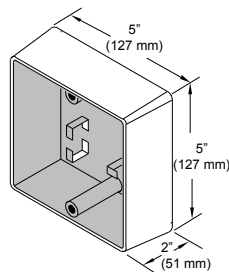

### MODEL: CM-53

**Size:** Double gang, std. depth

**Type:** Surface mount box

**Construction:** Double wall, black (ABS)

**Application:** Indoor/outdoor, for double gang switches and vestibule switches.

**For Switch Series:**

CM-500, CM-2510, C, CM-3200, CM-3500

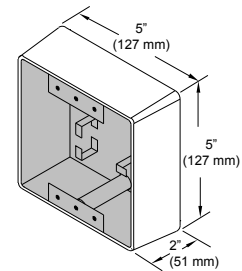

### MODELS: CM-54B (BLUE ONLY), CM-54BR (BLUE/RED), CM-54GR (GREEN/RED)

**Size:** 5 1/4" Square, std. depth

**Type:** Illuminated surface mount box

**Construction:** Double wall, black (ABS)

**Application:** Illuminated push plate switch enclosure, (room for wireless transmitter.)

**For Switch Series:**

CM-45, CM-46, SPDT only

**Note:** Insert is clear polycarbonate

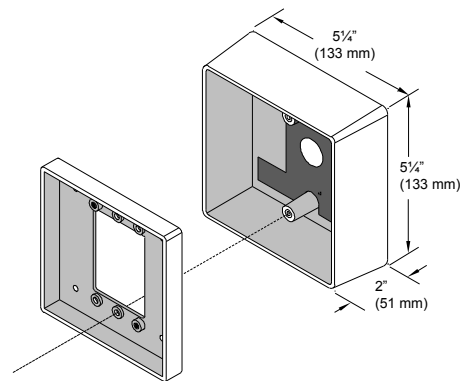

### MODEL: CM-63CBL

**Size:** 5" Square, std. depth

**Type:** Surface mount box,

**Construction:** Double wall, black (ABS)

**Application:** Indoor/outdoor, wired. Required for wireless.

**For Switch Series:** CM-60

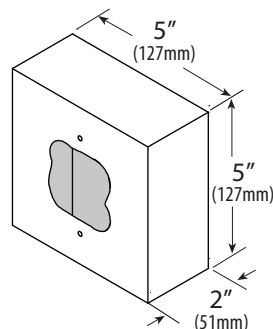

### MODEL: CM-48AL

**Size:** Double gang, shallow

**Type:** Surface mount box

**Construction:** Anodized aluminum

**Application:** Indoor/outdoor, wired.

**For Switch Series:**

CM-45, CM-46, CM-41 (Requires CM-49C adaptor plate, sold separately)

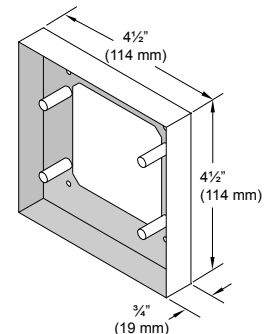

# CAMDEN MOUNTING BOXES

## MODEL: CM-44

**Size:** Double gang, shallow

**Type:** Offset surface mount box

**Construction:** Stainless steel

**Application:** For mounting 4 1/2" square switches on narrow jambs, indoor/outdoor, wired.

**For Switch Series:**

CM-41, CM-45, CM-46

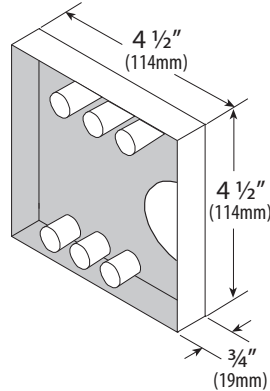

## MODEL: CM-540B

**Size:** Double gang, shallow

**Type:** Semi flush mount box

**Construction:** Flame and impact resistant black polymer (ABS)

**Application:** Indoor/outdoor, wired

**For Switch Series:**

CM-41, CM-45, CM-46

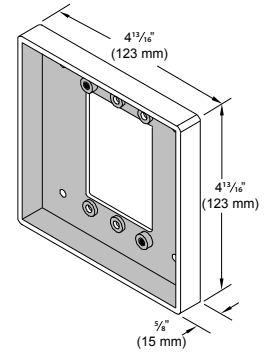

## MODEL: CM-67

**Size:** Double gang

**Type:** Sleeve for standard 4" x 4" surface electrical box

**Construction:** Heavy gauge stainless steel

**Application:** Adds brushed SS finish to standard electrical box

**For Switch Series:**

CM-41, CM-45, CM-46, CM-60

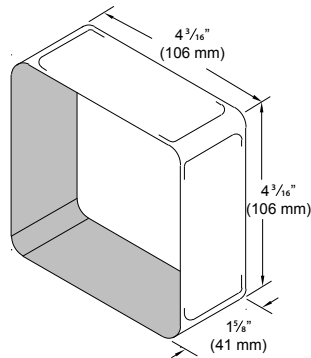

## MODEL: CM-68AL

(Anodized Aluminum finish)  
CM-68BZ (Anodized dark bronze finish)

**Size:** Double gang, shallow

**Type:** Surface mount box

**Construction:** Anodized aluminum

**Application:** Indoor/outdoor, wired

**For Switch Series:**

CM-60 (Requires CM-49C adaptor plate, sold with switch)

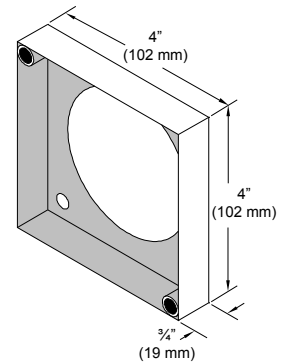

## MODEL: CM-440

**Size:** Double gang

**Type:** 5" flush dress plate

**Construction:** Stainless steel

**Application:** For mounting 4 1/2" round switch on standard single and double gang electrical box

**For Switch Series:** CM-40

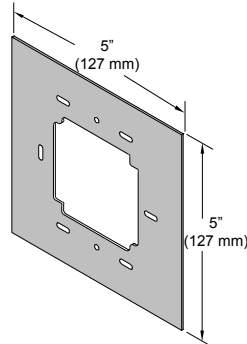

## MODEL: CM-660

**Size:** Double gang

**Type:** 6 1/2" flush dress plate

**Construction:** Stainless steel

**Application:** For mounting 6" switches on standard single, double gang and 4" square electrical boxes

**For Switch Series:**

CM-45, CM-46, CM-60

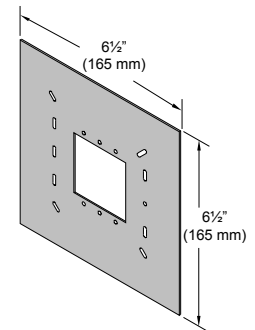

## MODEL: CM-49C

**Size:** Double gang

**Type:** Adapter plate

**Construction:** Galvanized steel

**Application:** For mounting CM-41, CM-45, CM-60 switches on double gang and 4" square mounting boxes

**For Switch Series:**

CM-45, CM-46 (included with CM-60)

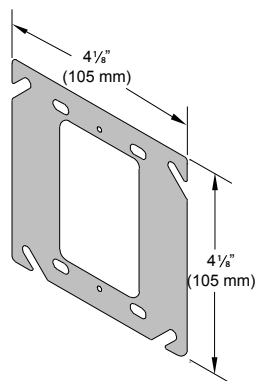

## 4 1/2" ROUND SWITCH MOUNTING ENCLOSURES

### MODEL: CM-47S

**Size:** 5" round, std. depth  
**Type:** Surface mount box  
**Construction:** Flame and Impact resistant black polymer (ABS)  
**Application:** Indoor/outdoor, wired. Required for wireless  
**For Switch Series:** CM-40

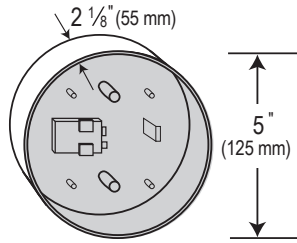

### MODEL: CM-59S

**Size:** 7 3/4" round, std. depth  
**Type:** Surface mount escutcheon  
**Construction:** Heavy gauge stainless steel  
**Application:** Vandal resistant indoor/outdoor, wired.  
**For Switch Series:** CM-40

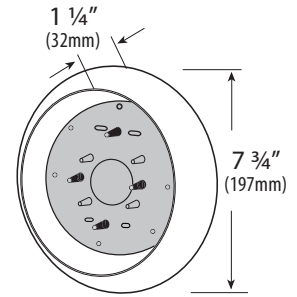

### MODEL: CM-49

**Size:** 8 3/4" round, 1 13/16" depth  
**Type:** 2 pcs. surface or semi flush mount escutcheon, gasket and adapter plate included  
**Construction:** Flame and impact resistant black polymer (ABS)  
**Application:** Vandal resistant indoor/outdoor  
**CM-49A:** Semi flush mounting on single gang electrical box, wired  
**CM-49B:** Surface mount. Wired, required for wireless. Must be used with CM-49A  
**CM-49C:** Adapter plate to mount CM-49A on double gang and 4" square electrical box  
**CM-49G:** Gasket for CM-49A or CM-49B  
**For Switch Series:** CM-40

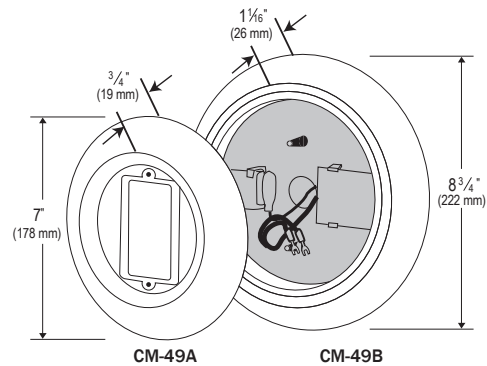

## 6" ROUND SWITCH MOUNTING ENCLOSURES

### MODEL: CM-69S

**Size:** 6 1/2" round, std. depth  
**Type:** Surface mount box  
**Construction:** Flame and Impact resistant black polymer (ABS)  
**Application:** Indoor/outdoor, wired. Required for wireless  
**For Switch Series:** CM-60

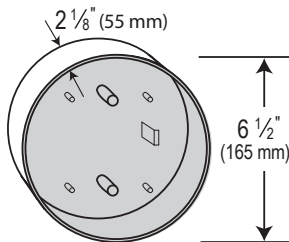

### MODEL: CM-89S

**Size:** 9 5/8" round, std. depth  
**Type:** Surface mount escutcheon  
**Construction:** Heavy gauge stainless steel  
**Application:** Vandal resistant indoor/outdoor, wired.  
**For Switch Series:** CM-60

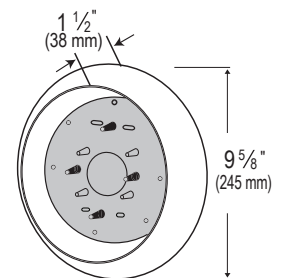

### MODEL: CM-79

**Size:** 9 5/8" round, 1 13/16" depth  
**Type:** 2 pcs. surface and semi flush mount escutcheon, gasket and adapter plate included  
**Construction:** Flame and impact resistant black polymer (ABS)  
**Application:** Vandal resistant indoor/outdoor  
**CM-79A:** Semi flush mounting on single gang electrical box, wired  
**CM-79B:** Surface mount. Wired, required for wireless. Must be used with CM-79A  
**CM-79C:** Adapter plate to mount CM-79A on double gang and 4" square electrical box  
**CM-79G:** Gasket for CM-79A or CM-79B  
**For Switch Series:** CM-60

